

### 5.7.3 Landscape framework

The vision for Grandhome is to create a settlement with a high proportion of open space accommodating a full range of uses such as formal recreational facilities and informal places for rest and relaxation, as well as natural, untamed areas that support biodiversity.

Figure 5.26: Landscape uses within Grandhome



Figure 5.27: Landscape Framework- elements

**EXISTING WOODLAND**

- existing woodland to be retained and actively managed
- monoculture plantation will be replaced over time with a mix of native species
- planting designed to optimise habitat value
- informal paths provided for public access



**WOODLAND**

- new mixed-species, structurally diverse woodland
- based on key native deciduous and coniferous species
- designed for both amenity and ecological purposes
- low proportion of understorey plants to maintain sightlines and encourage public access



**TREE BELTS**

- tree belts on ridgelines
- extends the characteristic Carrot Belt feathered silhouette on the city skyline
- acts as green/soft subdividing filters running through the development
- creates connected ecological corridors between woodland blocks
- orientated north-south to avoid creating dense shade
- open understorey with informal paths provided for public access



**MEADOW+COPSE PARKLAND**

- informal parkland weaving between more formal recreational spaces
- with open, dry and wetland grass areas, potentially with a variety of management regimes
- for informal amenity purposes and to create important grassland habitats.
- sculpted earth shaping may be used to create visual interest and guide views and patterns of movement
- copses of trees will be arranged to complement the earthshaping
- the space will be crossed by a network of formal and informal paths



**AVENUE**

- formal street tree planting
- single or double rows, opposite or staggered
- with or without verges
- hardy species with distinctive form and/or seasonal effects



**PEDESTRIAN GREEN LINKS**

- pedestrian/cycle-priority links through blocks
- predominantly hard with localised planting where street widens or in small squares
- other greening to be provided by resident's pots/window boxes, climbers on walls, garden planters



**PLAY ZONES**

- identified play areas
- exploiting surrounding landscape character to create diverse play environment
- includes formal and informal play environments, including natural play
- different age groups catered for, as per best practice



**SPORTS FACILITIES**

- sports facilities for shared school and commu



**LOCAL PARK**

- public gardens at the heart of a neighbourhood
- integrating existing features such as trees, burns or stone walls
- lawn areas for informal recreation
- mix of formal and informal tree planting to subdivide the space, frame views and define activity zones
- may incorporate facilities such as seating, shelter, bowling green, remembrance garden, community orchard



**CIVIC SPACE**

- formal spaces around civic buildings
- may include hard and/or soft landscaping
- includes flexible space for public gatherings and events
- potential sites for civic art/commemoration features
- includes parking for events



**SUDS**

- infrastructure for sustainable drainage
- wherever possible, will also provide an amenity resource and/or enhance biodiversity



**EDGE/BUFFER LANDSCAPE**

- structural edge planting to screen or filter views
- decorative species used along visible edges
- designed to contribute to the composition of any views to the developm
- multifunctional landscapes, incorporating suds, informal play or paths, and generally designed to enhance biodiversity



**ALLOTMENTS**

- land set aside for individuals or community groups to grow their own food or flowers
- may include traditional allotments or community/school gardens or orchards



The Grandhome masterplan includes a range of open spaces, with many types of greens and uses within each neighbourhood. The detailed allocation of each type of space will be outlined in the forthcoming Masterplan Statements. However, each space's range of uses and features can be described as follows:

- **Public open spaces** will be designed to be multifunctional and flexible to ensure that they are used to the full.
- **Watercourses** existing within the development provide an opportunity to enhance and fully incorporate within the development layout as part of the network of sustainable urban drainage system (SUDs) and to enhance public spaces. All watercourses will be protected within a suitable area of open space in accordance with Aberdeen City Council's Natural Heritage Supplementary Guidance.

As per policy and best practice, all existing watercourses have been retained and incorporated into the masterplan layout. Two small streams on the west edge of the site, plus two manmade drainage ditches and a flooded

quarry to the east have been integrated within public green space and developed as attractive landscape features. The hydrological regime around the flooded manganese quarry and ditches is being further investigated to determine how these can be retained to:

- assist with the efficient management of water
- provide an attractive landscape feature (while preserving public safety)
- enhance biodiversity

It is proposed that the field drainage channels running east-west and north-south from the quarry are integrated with the townscape, as small watercourses in narrow landscape corridors. The structures at bridging points will be kept minimal and leave a continuous channel bed. Following traditional towns and villages, the character of the watercourses will change depending on the nature of the surrounding context, being more rustic in lower density areas but becoming more formal in more dense, urban areas. Details of the design will be provided during masterplan development.

Given the proximity of the

Table 5.2: Landscape Framework - elements

Framework element	Description
<b>Existing woodland</b>	<ul style="list-style-type: none"> <li>• existing woodland that will be retained and actively managed</li> <li>• monoculture plantation will be replaced over time with a mix of native species</li> <li>• planting will be designed to optimise habitat value</li> <li>• informal paths will be provided for public access</li> </ul>
<b>Woodland</b>	<ul style="list-style-type: none"> <li>• new, mixed-species, structurally diverse woodland will be planted</li> <li>• woodland will incorporate native deciduous and coniferous mixes</li> <li>• it will be designed to meet objectives for both amenity and ecology</li> <li>• there will be a low proportion of understorey plants to maintain sightlines and encourage a sense of security</li> </ul>
<b>Tree belts</b>	<ul style="list-style-type: none"> <li>• the characteristic Carrot Belt feathered silhouette on the city skyline will be protected and extended</li> <li>• tree belts will be used as green/soft subdividing filters running through the development</li> <li>• tree belts create connected ecological corridors between woodland blocks</li> <li>• belts should be orientated north-south to avoid creating dense shade</li> <li>• they will have an open understorey with informal paths provided for public access</li> </ul>
<b>Meadow + copse parkland</b>	<ul style="list-style-type: none"> <li>• informal parkland will weave between, and connect, more formal recreational spaces</li> <li>• it will include a variety of open, dry and wetland grass areas, potentially with a variety of management regimes</li> <li>• it will be used for informal amenity purposes and to create important grassland habitats</li> <li>• sculpted earth shaping may be used to create visual interest and guide views and patterns of movement</li> <li>• copses of trees will be arranged to complement the earth-shaping</li> <li>• the space will be crossed by a network of formal and informal paths</li> </ul>
<b>Town park</b>	<ul style="list-style-type: none"> <li>• the park will incorporate a formal public park and/or public gardens; it will be a destination at the heart of the new development</li> <li>• the ground may be sculpted to create a series of south-facing terraces</li> <li>• ornamental tree species/arboretum planting will be introduced</li> <li>• the park may include a series of distinct garden areas with different characters and purposes</li> <li>• there will be focal spaces at meeting points, for resting and to exploit scenic views</li> <li>• formal facilities such as seating, shelters, play areas, minor sports will be incorporated</li> </ul>
<b>Local park</b>	<ul style="list-style-type: none"> <li>• these will be public gardens at the heart of each neighbourhood</li> <li>• existing features such as trees, burns or stone walls will be integrated with the landscape of the park</li> <li>• there will be lawn areas for informal recreation</li> <li>• a mix of formal and informal tree planting will subdivide the spaces, frame views and define activity zones</li> <li>• formal facilities such as seating, shelter, bowling green, remembrance garden, community orchard will be incorporated</li> </ul>

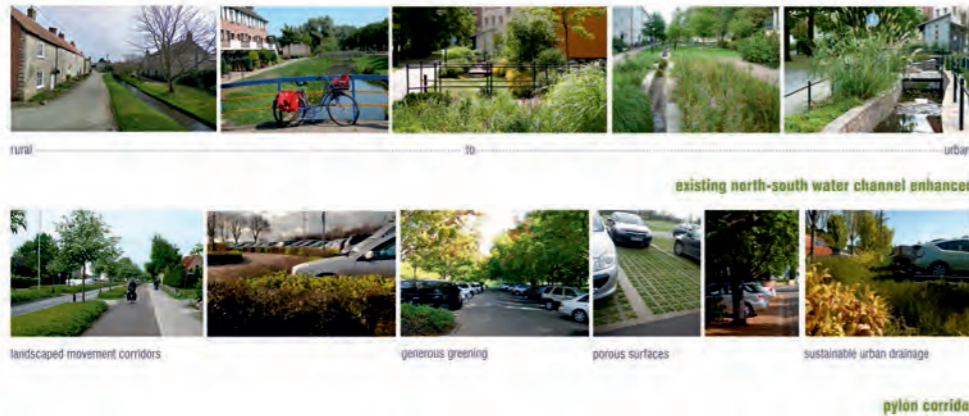

Figure 5.27b: Watercourses: Green corridors in urban core - exemplar images

airport, a proportionate approach will be taken in relation to the introduction and use of waterbodies.

- **Safety and security** will be promoted by applying 'Secure by Design' principles such as ensuring public open space is overlooked by built development, is appropriately lit and designed to minimise disturbance and nuisance to neighbours.
- **Lighting** will be introduced judiciously so that while key paths and public spaces will be well lit, wooded areas and wilder green spaces will be less fully lit or unlit, to minimise the impact on wildlife.

Phased Masterplans must ensure connectivity of habitats within and through the whole site. Justification and evidence will be provided to ensure that this is the case.

Framework element	Description
<b>Civic space</b>	<ul style="list-style-type: none"> <li>• civic squares will be formal, urban spaces, usually around civic buildings</li> <li>• such spaces may include hard and/or soft landscaping</li> <li>• they will include flexible spaces for public gatherings and events</li> <li>• these are potential sites for civic art/commemoration features</li> <li>• provision will be made for parking for events</li> </ul>
<b>Village green</b>	<ul style="list-style-type: none"> <li>• greens are informal green spaces as focal points for individual neighbourhoods</li> <li>• existing features such as trees, burns or stone walls will be protected and integrated</li> <li>• greens will be predominantly soft, with lawn areas and ornamental trees</li> <li>• they will be designed for flexible use by surrounding residents</li> </ul>
<b>Avenue</b>	<ul style="list-style-type: none"> <li>• avenues will have formal street tree planting</li> <li>• trees will be planted in single or double rows, opposite or staggered</li> <li>• avenues may be designed with or without verges</li> <li>• hardy species with distinctive form and/or seasonal effects will be selected</li> </ul>
<b>Pedestrian green links</b>	<ul style="list-style-type: none"> <li>• the green links are pedestrian/cycle-priority links running through blocks</li> <li>• they will be predominantly hard with localised planting where the lane widens or where there are widenings or small squares</li> <li>• other greening will be provided by resident's pots/window boxes, climbers on walls, garden planting and the like</li> </ul>
<b>Play zone</b>	<ul style="list-style-type: none"> <li>• formal play areas will be provided</li> <li>• play areas will be designed to exploit the surrounding landscape character to create diverse play environments</li> <li>• play environments may be formal or informal and will include natural play</li> <li>• different age groups will be catered for, as per best practice</li> </ul>
<b>Sports facilities</b>	<ul style="list-style-type: none"> <li>• sports facilities will be provided, for shared school and community use</li> </ul>
<b>Allotments</b>	<ul style="list-style-type: none"> <li>• land will be set aside for individuals or community groups to grow their own food or flowers</li> <li>• such areas may include traditional allotments or community/school gardens or orchards</li> </ul>
<b>SUDs</b>	<ul style="list-style-type: none"> <li>• this includes infrastructure for sustainable drainage</li> <li>• wherever possible, SUDs features will also provide an amenity resource and/or be designed to enhance biodiversity</li> </ul>
<b>Edge/buffer landscape</b>	<ul style="list-style-type: none"> <li>• structural edge planting will be introduced to screen or filter views</li> <li>• decorative species will be selected for use along visible, developed edges</li> <li>• buffer planting will be designed to contribute to the composition of key views to the development</li> <li>• buffer landscapes will be multifunctional, incorporating suds infrastructure or paths for example, and generally designed to enhance biodiversity</li> </ul>

### 5.7.4 Open space standards

Approximately 85 hectares of public open space will be provided within the Grandhome development, 40 hectares more than the minimum required by the Aberdeen City Council Open Space Supplementary Guidance.

The open space is configured as a connected network, within the site and linking to corridors beyond the site, to expand and enhance the wider Green Space Network in north Aberdeen.

There will be a full complement of open spaces designed to both support biodiversity and for the community to use for a broad range of active and passive recreation.

The scheme complies with both PAN 65: Planning and Open Space and Aberdeen City Council Open Space Supplementary Guidance.

All of the categories of open space described in the SG are provided, as well as additional types of open space such as civic spaces, village greens, a major town park and local neighbourhood parks.

In light of the findings of the Open Space Audit, it has been assumed that the Grandhome development will be self-contained in terms of public



Figure 5.28: All homes will be within a 20 minute walk from a major town park.

■ Proposed Green Space  
 ■ Proposed Town Park



Figure 5.29: Homes will be within a 5 minute walk of children's play zones.

■ Proposed Green Space  
 ● Play Zone  
 ● Large Scale Play Zone

open space provision. All space categories are provided for within the site at a level beyond the minimum required in the guidance except for formal sports which are partly catered for by existing neighbouring sports facilities within walking distance of Grandhome.

There are 32 hectares of Natural Greenspace and Green Corridors in Grandhome. Ultimately, the area of 'natural' landscape is likely to be greater than this, but for the purposes of the measuring exercise 'Natural Greenspace and Green

Corridors' have been assumed to comprise all of the green open space excluding the town and neighbourhood parks, civic spaces, village greens, play areas, avenues/green streets, edge/buffer landscapes, sports grounds and allotments.

All types of public open space will continue to be assessed throughout the refinement of the masterplan, in terms of walking distance, size and nature, to ensure that the new community at Grandhome has convenient

access to a suitable range of high quality, placed-based recreational facilities.

Several potential options for management of the public open space are currently being assessed, including those set out in the SG. The implications for long term management and maintenance will guide design decisions through all stages of masterplan development. In addition, detailed proposals for the maintenance of individual open

spaces will be developed through the Masterplan process for each phase.

A tree survey and a woodland management plan will be required to be submitted as part of the detailed planning applications for each phase of development"



Figure 5.30: Neighbourhood parks are within a 10 minute walk of all homes.

■ Proposed Green Space  
 ■ Proposed Neighbourhood Park



Figure 5.31: Outdoor sports are within a 15 minute walk of all homes.

■ Proposed Green Space  
 ■ Proposed Sports Facilities

Table 5.3: Grandhome Open Space Provision

Formal Open Space	Number	Appropriate Area
Play Zone/Other Play Areas*	9 No.	4.8 Hectares
Large Scale Play Zone*	1 No.	2,500m2
Outdoor Sports Areas*	3 No.	9.5 Hectares
Allotments or Community Gardens	4 No.	2.3 Hectares
Town Park	1 No.	7.6 Hectares
Neighbourhood Parks North and West	2 No.	4.3 Hectares
Village Greens	5 No.	1.5 Hectares
Civic Square	5 No.	2 Hectares
<b>Total Formal Open Space</b>		<b>32.2 Hectares</b>

\* ACC open space categories as per ACC Open Space Supplementary Guidance

Table 5.4: Open Space Standards - compliance with ACC Open Space Supplementary Guidance

Informal Open Space				
Natural Greenspace And Green Corridors*	Within 400M>2Ha; 2000M>5Ha	1 Ha	16 Ha	32 Hectares
Other Landscaped Areas				18.4 Hectares
<b>Total Informal Open Space</b>				<b>50.4 Hectares</b>
<b>Total Open Space</b>				<b>82.6 Hectares</b>

\*ACC open space categories as per ACC Open Space Supplementary Guidance

## Path network

The path network is designed to provide a range of safe and attractive pedestrian/ cycle links within and between neighbourhoods, as well as to offer a choice of longer walking/ cycling circuits around the new development and out into the countryside beyond. Specifically, the new network will link to existing parts of the Core Paths network that approach the site, at the north and south ends of Whitestripes Avenue, and ultimately to crossing points on the Don.

- ### Primary active travel paths

These form 'first tier' links between neighbourhoods and to key destinations outside the site. These routes link to the existing Core Paths network for example, and form links between neighbourhood centres, schools and key play areas.

These would be segregated, all-hour, all-weather paths, Whether they run parallel to traffic routes or through green spaces.

- ### Secondary paths

Secondary paths would extend out from the primary paths and link to secondary destinations. They may also include attractive alternatives to the primary path network that may not be all-hour, all-weather. For example, secondary paths include those running through wooded areas that may be designed to complement the surrounding natural

Figure 5.32: Proposed key paths network

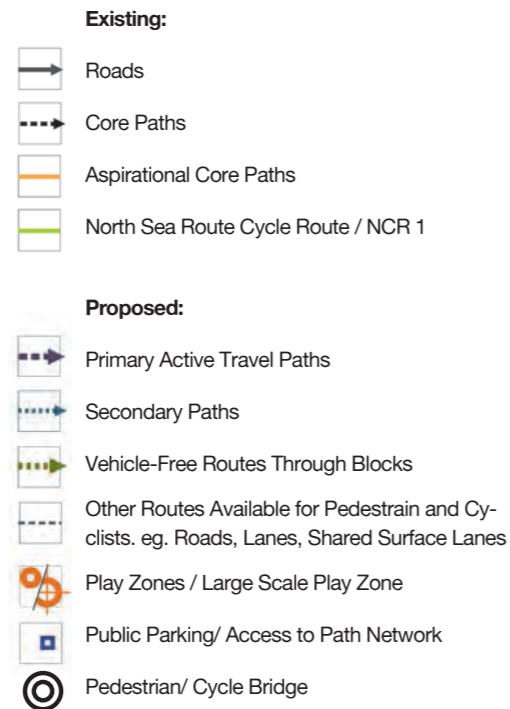

landscape by being built to a lower specification eg they may be narrower, surfaces may be more informal, or the paths may not be lit.

- ### Safe Routes to Schools

Pedestrian routes will be designed to ensure SRS principles are complied with and considered through the Transport Assessment.

- ### Vehicle-free routes through blocks

In places, shared-surface routes run through residential blocks providing spaces where children can play safely; these also provide convenient shortcuts for people moving through the area on foot or by bike.

Parking will be provided at key points at the edge of the network where people from elsewhere in the city can gain access to the path network.



## 5.8 Architectural Strategy

### 5.8.1 Housing

Each of Grandhome's neighbourhoods will feature a wide variety of housing tenures, sizes and types, including detached houses, terraced houses, cottages and flats. In terms of size, housing mix will reflect current and likely future market demand in Aberdeen by focusing on the provision of high quality family homes while catering for smaller household sizes. An indicative composition of housing mix may include the following:

One-bed	10-15%
Two-bed	20-25%
Three-bed	30-40%
Four-bed	25-30%
Five-bed+	5%

Development will span the full transect, providing high-density urban living in the neighbourhood centres and more rural family homes on the outskirts. This variety of housing will allow for a diverse group to settle within Grandhome, and enable families to then remain within the community should their household numbers or circumstances change over time. 25% affordable housing will be

provided on a tenure-blind basis, including provision for the LDP required Gypsy and Traveller site (see Figure 5.8), the final site for which will be determined through the masterplanning process. The site will be designed to accommodate a maximum of six pitches.



Figure 5.33: Indicative view- Terraced houses just off the high street offer convenience and the opportunity to live in close proximity to the town centre's offices and amenities.



Figure 5.34: Indicative view- Cottages and semi-detached houses feature in the residential blocks. In this case, the houses front onto a shared garden.

### 5.8.2 Architectural typologies

Beyond studying street compositions, the design team also studied the proportions of building across Aberdeen, with a focus on Old Aberdeen and north Donside. The following pages detail the proportions, architectural typologies and materials studies. This work has been used to inform the design of house types for Grandhome, which will ultimately include homes of a range of sizes, costs and styles. These homes will follow both traditional and contemporary aesthetics, but are likely to adhere to similar proportions, ensuring they sit together well as an ensemble.

A sampling of the designers' studies can be introduced as follows:



**Cluny's Port**  
Detached single family house

Cluny's Port is a traditional North Donside home, including both stone and brick within its façade. The house is centred on a single door and central window, with the proportions on either side forming two roughly 45 degree squares.

A Grandhome house study follows this symmetry, but moves inward slightly, with the two squares centred on the door's middle line, rather than its outer edges.

Figure 5.35: Study of Cluny's Port building proportions informing the system used in Grandhome's single family terraced houses

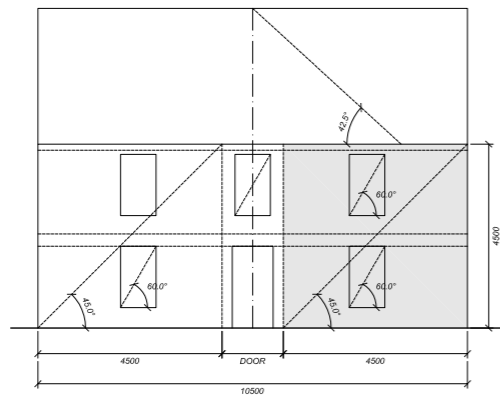

**No. 88 High Street**  
Terraced single family house

A render, terraced house on the high street offers a contrast to the symmetrical Cluny's Port. In this case, the door remains relatively centrally placed, surrounded by two rows of windows, with different proportions on the ground and first floors. Each of these rows also takes on a different rhythm, whether clustered in pairs or independently spaced.

The design team used these proportions to generate a simpler façade: in this case, the house facade comprises two forty five degree rectangles, with its windows featuring diagonals that range between 57 and 63.5 degrees.

Figure 5.36: Study of Grant Place's cottage building proportions informing the system used in Grandhome's single family terraced houses

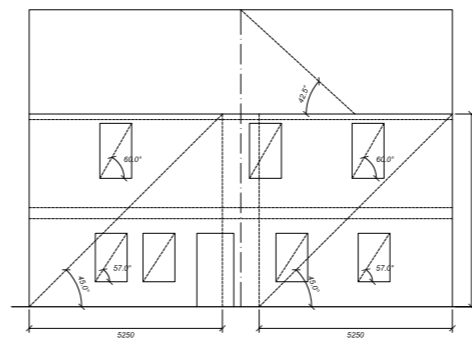

**No. 1 High Street**  
Terraced single family house

This end terrace building offers another approach, featuring an asymmetrical composition of windows. The door is located on the far right, likely opening onto a hall. The windows are then of different proportions on the ground and first floors, with the first floor windows nearly matching the door in size.

Figure 5.37: Study of Old Aberdeen High Street terrace's building proportions informing the system used in Grandhome's single family terraced houses

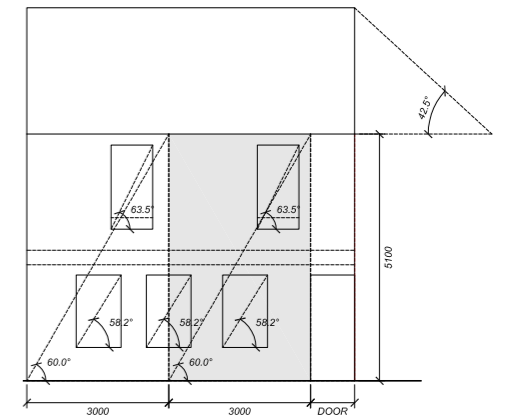
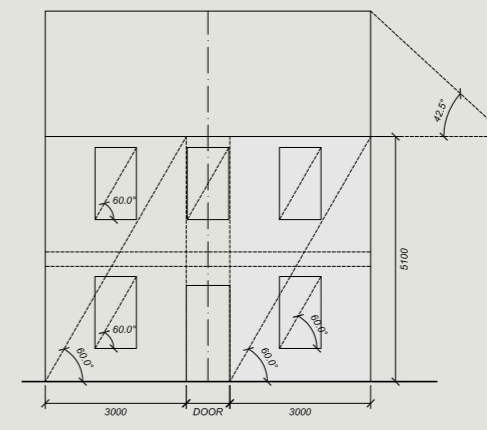
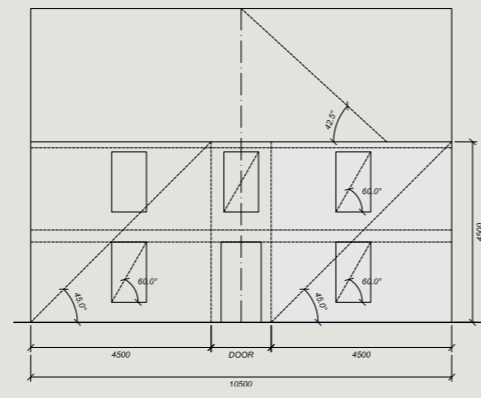
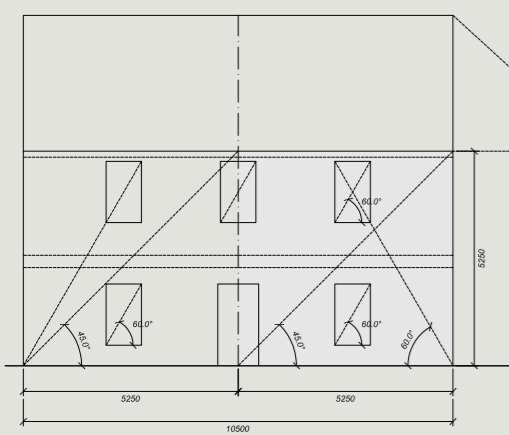

Figure 5.40: Resulting proportional studies inspired by the local existing typologies (above).



**No. 91 High Street**  
Terraced mixed use building

This mixed use building on Old Aberdeen high street includes large windows and a strong silhouette due to its central chimney. This flexible building type is currently in commercial use, with a bank on the ground floor and a flat above. However, the building type is also suitable for flats or even a single family home.

The red tiled roof – pitched at 42.5 degrees – is characteristic of north Aberdeen. The windows are positioned at 60 degrees, and do not align between the ground floor and first floor.

Figure 5.38: Study of Old Aberdeen mixed use building proportions informing the system used in Grandhome's single family mixed use house

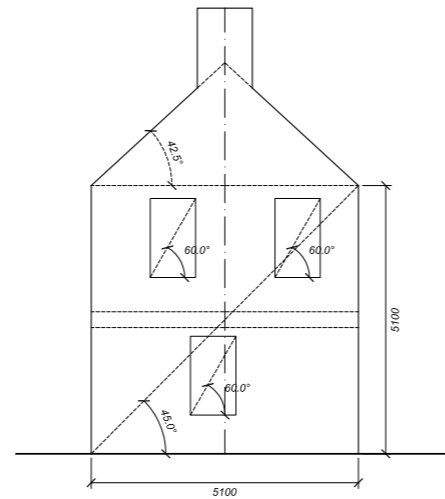

**No. 2 Grant's Place**  
Semi-detached single storey cottage

This single storey semi-detached home on Grant's Place offers a model for relatively high-density development, achievable with modest homes with their own gardens. Homes of a similar type will be developed for Grandhome, and may be popular with retirees and others looking to downsize.

The home on Grant's Place features a red tile roof and a stone façade, with large, traditionally detailed windows. Tile roofs of this kind are typical of north Aberdeen, and the material will be incorporated into Grandhome.

Figure 5.39: Study of Grant Place cottage building proportions informing the system used in Grandhome's semi-detached single storey house.

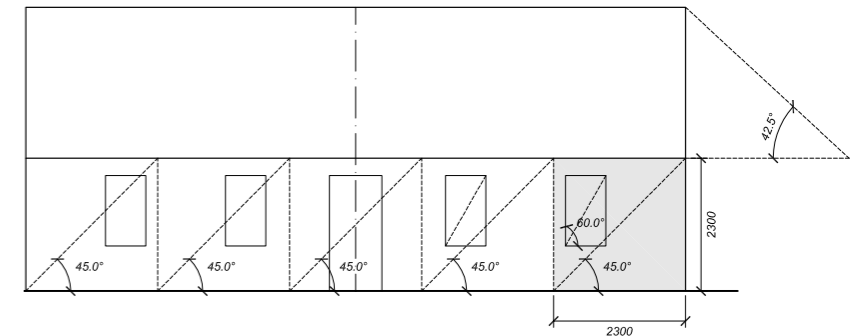

Figure 5.41: Resulting proportional studies inspired by the local existing typologies (above).

